

BlueAnt®

S4

TRUE HANDSFREE  
VOICE CONTROLLED  
CAR SPEAKERPHONE

User Guide





# Contents

|  |    |
|--|----|
| Introduction.....                          | 6  |
| Remove the Protective Cover.....           | 7  |
| Charge Your S4.....                        | 7  |
| Pair the S4 with your Phone.....           | 8  |
| Install the S4 in your Car.....            | 10 |
| Using the Handsfree Trigger.....           | 11 |
| Handsfree Trigger Battery Saving Mode..... | 12 |
| Reconnecting to the S4.....                | 13 |
| Use Your Voice to Make Phone Calls.....    | 14 |
| Use Your Voice to Answer Calls.....        | 14 |
| Use Your Voice to Access the World.....    | 15 |
| List of Voice Commands.....                | 16 |

|   |    |
|---|----|
| Transferring your Phonebook Contacts to the S4.....               | 18 |
| Automatically Transferring your Phonebook Contacts to the S4..... | 18 |
| Manually Transferring your Phonebook Contacts to the S4.....      | 18 |
| Updating your Phonebook Contacts on the S4.....                   | 19 |
| Listening to Audio.....   | 20 |
| Adjusting the Volume.....   | 21 |
| Using 2 Phones with the S4 (Multipoint).....                      | 22 |
| Which Phone is Used for Calls?.....                               | 22 |
| Multiple Calls (Call Waiting)*.....                               | 23 |
| Switching the S4 On and Off.....                                  | 24 |
| Firmware Upgrades.....  | 24 |
| Function Reference.....   | 25 |
| Phone Specific Tips and Tricks.....                               | 27 |

|                           |    |
|---------------------------|----|
| Android.....              | 27 |
| Apple® iPhone® .....      | 27 |
| BlackBerry.....           | 28 |
| Other Models.....         | 28 |
| Troubleshooting.....      | 29 |
| Resetting the S4.....     | 34 |
| Specifications.....       | 35 |
| Help and Support.....     | 36 |
| Terms and Conditions..... | 37 |



# BlueAnt

Speak to me

## Introduction

The S4 speakerphone is the first true handsfree voice controlled Bluetooth car speakerphone.

There is no need to take your hands off the wheel or your eyes off the road to use the S4. Simply say the trigger phrase **BlueAnt Speak To Me™** and the S4 will be ready for your voice commands.

You can make outgoing calls and answer incoming calls using just your voice, and you will always know who is calling you without looking at your phone because the S4 will read out the caller's name or number when the phone rings.

Read on and learn how to use the S4 to listen to turn-by-turn GPS directions, play music, and access a world of information such as traffic reports, weather and sports results.

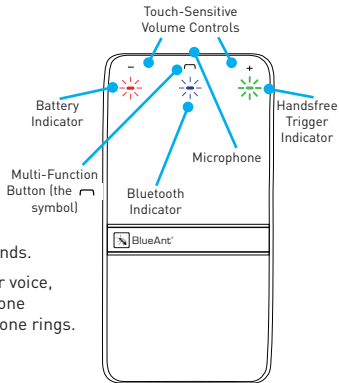

## Remove the Protective Cover

The plastic cover on your S4 is intended to protect it during transit. Please remove it before using your S4.

## Charge Your S4

Your S4 has been given an initial partial charge to get you started, but for best results we recommend you charge it using the supplied USB cable and adaptor:

- > You should charge the S4 whenever it announces that the battery is **Very Low**.
- > A full charge takes about 3-4 hours.
- > During charging, the battery indicator light turns red.
- > When the light goes out, the charge is complete.

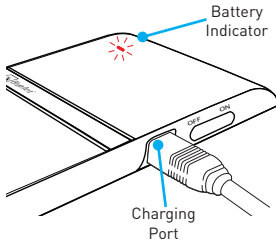

## Pair the S4 with your Phone

To use the S4 you need to pair it with your phone.

1. Slide the power switch on the side of the S4 to the ON position.
2. If this is the first time you have used the S4 it will go straight to pairing mode. The voice prompts will start to talk you through the pairing process and the light will flash blue.

For subsequent pairings, say **BlueAnt Speak To Me**, wait for the S4 to ask you to **Say A Command** and then say **Pair Me**.

3. Follow the voice prompts to pair the S4 with your phone. The pairing code is **0000** (four zeros).

## Transfer your Phonebook

Once the pairing is complete your S4 will attempt to transfer the contacts from your phonebook so that it can announce the names of incoming callers.

**Note:** If your phone prompts you to allow a connection to the S4, you **must** select "YES" or "OK".

## BlackBerry®

If you are using a BlackBerry smartphone you may see a message like this one.

Select “Don’t ask this again” so that a tick appears in the box, and then choose “YES”.

## Android™

On Android devices a message about the phonebook transfer may appear in the notifications area at the top of the screen.

In order to transfer your contacts you must swipe your finger over this message and accept the phonebook transfer request from the S4.

## Automatic Transfer Not Supported

Some phones do not support automatic phonebook transfers. If this is the case on your phone the S4 will announce that it cannot transfer the contacts automatically.

See [“Manually Transferring your Phonebook Contacts to the S4” on page 18](#) for help.

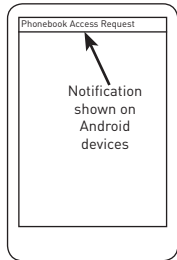
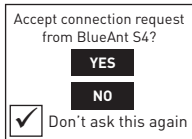

## Install the S4 in your Car

1. Slide the sun visor clip onto the edge of the car sun visor. Your S4 is supplied with a choice of visor clips so you can select the most appropriate one for your vehicle.
2. Attach the magnetic back of the S4 to the fixed sun visor clip.

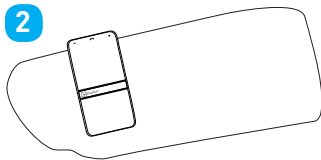
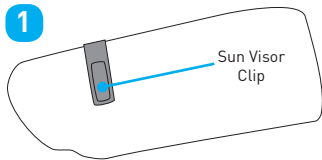

### Don't forget: Drive safely and within the law.

Please refer to the relevant national or local legislation regarding the usage of mobile devices while driving. Remember that **driving is your first priority**: please read the enclosed safety information booklet for tips on the safe use of your BlueAnt device.

## Using the Handsfree Trigger

Your S4 is designed to be a true handsfree device. Simply say the trigger phrase **BlueAnt Speak To Me** and the S4 will be ready to receive your voice commands.

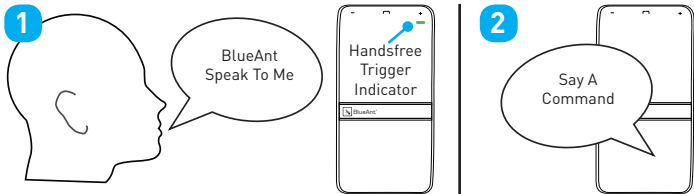

When the S4 asks you to **Say A Command**, immediately say one of the voice commands loudly and clearly.

**Note:** The handsfree trigger **only** works when the green handsfree trigger indicator light on the front of the device is on. This tells you that the S4 is listening for your voice.

## Handsfree Trigger Battery Saving Mode

Using the handsfree trigger gives you true handsfree operation, as the S4 is always listening for your voice.

If you want your S4 to run for longer between charges, slide the power switch to the middle position to activate "battery saving mode".

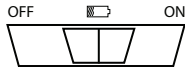

In this mode the S4 only listens for 2 minutes after the last action.

Once the 2 minutes are up, the green indicator light goes out and the S4 stops listening. To re-activate the S4, tap the  symbol instead of saying **BlueAnt Speak To Me**:

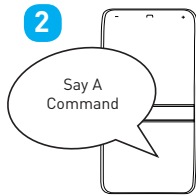
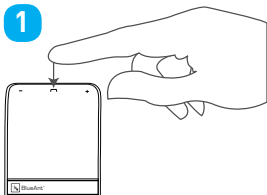

## Reconnecting to the S4

To save battery, the S4 goes into “sleep mode” when you are not using it.

If you take your phone out of range of the S4 for more than 2 minutes, the handsfree trigger switches off and “sleep mode” is activated.

When you come back, you **must** tap the  symbol to reconnect your phone and reactivate the trigger.

Alternatively, use the power switch to turn the S4 off when you get out of the car and then turn it back on again when you come back. The S4 will then automatically reconnect to your phone.



## Use Your Voice to Make Phone Calls

Say **BlueAnt Speak To Me** and wait for the S4 to ask you to **Say A Command**, then:

- > Say **Phone Commands** to activate the voice dial feature on your phone (if your phone supports voice dialing).
- > Say **Redial** to redial the last number you called on your phone.
- > Say **Call Back** to call back the last call you received on the S4.

## Use Your Voice to Answer Calls

When the phone rings, wait for the prompt to ask you if you want to take the call, and then say **Answer** or **Ignore**. Or:

- > Tap the  symbol once to accept the call.
- > Double tap the  symbol to reject the call.

During a call, tap the  symbol to end the call.

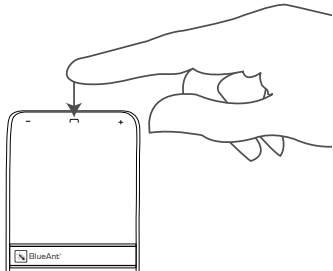

## Use Your Voice to Access the World

Your S4 provides you with voice access to the world by giving you stock quotes, news, sports updates, traffic information, weather, and more.

To access this function:

1. Say **BlueAnt Speak To Me** and wait for the S4 to ask you to **Say A Command**.
2. Say **Favorites** and wait for the S4 to ask you **Which Favorite?**
3. Say one of the following commands:

**Information**  
**Sports**

**Movies**  
**Stock Quotes**

**Navigate**  
**Traffic**

**News**  
**Weather**

**Note:** The availability of Favorites depends on your location and mobile carrier. In the USA, this function dials the Bing™ 411 service. Call charges may apply to this call.

If you are located outside the US, please see [www.blueantwireless.com](http://www.blueantwireless.com) for details on which services are available in your location.

## List of Voice Commands

When you want to do something, just say **BlueAnt Speak To Me**, wait for the S4 to ask you to **Say A Command**, and then say one of the following commands:

- > **Am I Connected?** — The S4 will check if your phone is connected, and attempt to connect if it is not.
- > **Call Back** — Calls back the last incoming call received on the S4.
- > **Check Battery** — Tells you the battery level on the S4.
- > **Favorites** — Wait for the S4 to ask you **Which Favorite?** then say one of the following:

**Information**  
**Sports**

**Movies**  
**Stock Quotes**

**Navigate**  
**Traffic**

**News**  
**Weather**

**Please Note:** The availability of **Favorites** depends on your location and mobile carrier. Call charges may apply.

- > **Pair Me** — Puts the S4 into pairing mode. Any connected phone will be disconnected.
- > **Phone Commands** — Activates your phone's voice dialing feature (if supported). Depending on your phone model, you may need to record voice tags on the phone to use this feature.

- > **Redial** — Redials the last outgoing call made on the connected phone.
- > **Sensitivity Level** — Configures the sensitivity of the S4's voice recognition.
- > **LED Light** — Turns the LEDs on or off. When the LEDs are set to off, they still light up when you turn the S4 on or off, but will not flash at other times.
- > **Update Phonebook** — Updates your phonebook contacts on the S4. If you add contacts to your phone, or change the numbers associated with existing contacts, then you will need to use this command to transfer the updated contacts to the S4.
- > **What Can I Say?** — Reads out a list of all the commands available on the current menu.

## Transferring your Phonebook Contacts to the S4

Your S4 uses Text To Speech technology (TTS) to read out the name of the person who is calling you. To do this, the S4 needs to store a copy of your phonebook contacts.

### Automatically Transferring your Phonebook Contacts to the S4

When you pair your phone with the S4 it will attempt to transfer the phonebook contacts automatically. The S4 stores up to 2,000 contacts per phone.

**Tip:** If you want to cancel the phonebook transfer, tap the  symbol on the top of the device.

### Manually Transferring your Phonebook Contacts to the S4

Some phones do not support automatic phonebook transfers: if this is the case on your phone then the S4 will instruct you to start sending contacts to the S4 manually. To do this:

1. Wait to be prompted to start sending contacts to the S4.
2. Go to your phonebook and select the contacts you want to send to the S4. Choose the option to “Mark All” or “Select All” if this is available on your phone (if this is not available, you will need to transfer each contact

individually).

3. Select the option on your phone to “send” or “beam” contacts, business cards, or v-cards via Bluetooth, and select the S4 from the list of Bluetooth devices. See your phone’s manual for help with this step.

**Note:** some phones do not support phonebook transfers at all. If this is the case, the S4 will read out the caller’s number instead.

## Updating your Phonebook Contacts on the S4



If you add or change entries in your phonebook then you need to update the contacts on your S4 by doing the following.

1. Say **BlueAnt Speak To Me**, and wait for the S4 to ask you to **Say A Command**.
2. Say **Update Phonebook**.
3. The S4 will attempt to transfer your phonebook automatically. If this is not possible on your phone then you will be prompted to upload the contacts manually.

## Listening to Audio

The S4 supports A2DP audio streaming. If your phone supports the A2DP profile then simply start playing music or any other audio (including turn-by-turn directions from a GPS application on your phone) and it will automatically transfer to the S4.

If the phone rings the audio will mute. You can use your voice to answer or ignore the call. Or:

- > Tap the  symbol once to accept the call.
- > Double tap the  symbol to ignore the call.

The audio will resume when the call ends.

If you want to exit A2DP streaming mode to do something else, tap the  symbol. The S4 will ask you to **Say A Command**. If you do not say a command within a few seconds the music will resume playing.

## Adjusting the Volume

The volume controls are touch sensitive.

Swipe your finger across the top of the S4 to adjust the volume.

You can also adjust the volume by pressing and holding the - or + symbols.

You can adjust the volume during calls, during music playback and you can also adjust the volume of the audio prompts.

Please note that each of these modes has its own independent volume setting.

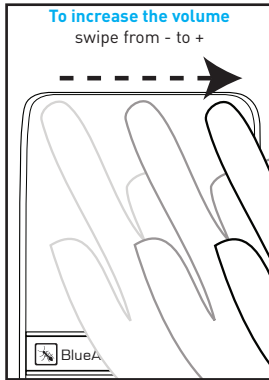
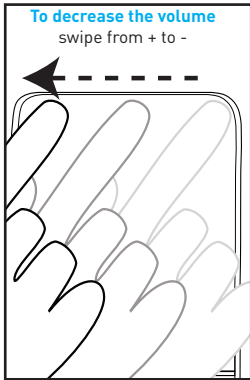

## Using 2 Phones with the S4 (Multipoint)

Up to 2 devices can connect to the S4 at the same time. If either phone rings, you can answer it with the S4.

Use the **Pair Me** command to put your S4 back into pairing mode to pair another phone. Any currently connected phone will be disconnected during pairing, so you will need to reconnect afterwards.

### Which Phone is Used for Calls?

When you have two phones connected to the S4 at the same time you can always answer an incoming call on either phone.

If you initiate a call through the S4 (for example by saying **Phone Commands**) then the call takes place on the **primary phone**: the one that connected to the S4 first.

**Note:** Only the primary phone can play music through the S4 via A2DP.

## Multiple Calls (Call Waiting)\*

If you receive an incoming call while you are already on a call the S4 will play a tone to alert you.

- > Press the + symbol on the S4 for about 1 second to put your current call on hold and answer the incoming call.
- > Press the - symbol on the S4 for about 1 second to end the current call and answer the incoming call.
- > Once you have a call on hold, you can switch between calls by pressing the + symbol for about 1 second.



**Note:** If one of the calls ends, some phones do not automatically resume the held call. If this happens, press the + symbol for about 1 second to release the hold and resume the other call.

**Tip:** If you are using multipoint, both phones remain connected during calls so you can also use these controls to switch between calls on both phones.

\* To use this feature, your phone and network must support call waiting.

## Switching the S4 On and Off

To switch the S4 on or off, use the hardware power switch located on the side of the device.

- > Slide the switch to the ON position to use the S4 in handsfree trigger mode.
- > Slide the switch to the  position to use the S4 in battery saving mode. In this mode the S4 will only listen for the trigger phrase for 2 minutes after you do something. Once the 2 minutes are up you must tap the  symbol to activate the S4's voice recognition.
- > Slide the switch to the OFF position to turn the S4 off.

## Firmware Upgrades



To enhance your experience, we are continually upgrading the S4 firmware.

From time to time we will make upgrades available on our website for you to download and apply to your S4. Go to [www.blueantwireless.com](http://www.blueantwireless.com) for full details on the latest upgrades available for your S4.

You must register your product online at [register.blueantwireless.com](http://register.blueantwireless.com) for access to firmware upgrades.

## Function Reference

- > **Standby Mode** means connected to a device but not on a call.
- > **Idle Mode** means the S4 is on but not connected to any devices.

| S4 Function            | Do This  | When                                     |
|------------------------|--|--|
| Volume Up              | Swipe from - to +<br>Or: press and hold +  | Idle/Standby/Active call/Music Streaming |
| Volume Down            | Swipe from + to -<br>Or: press and hold -  | Idle/Standby/Active call/Music Streaming |
| Activate voice control | Tap the  symbol                       | Idle/Standby                             |
| Enter pairing mode     | Press the  symbol for about 6 seconds | Idle/Standby                             |
| Cancel pairing mode    | Tap the  symbol                       | Pairing mode                             |

| <b>S4 Function</b>                                   | <b>Do This</b>   | <b>When</b>   |
|--|--|---|
| Answer a call  | Tap the ☞ symbol                                       | Ringing   |
| End a call   | Tap the ☞ symbol                                       | Active call   |
| Reject a call  | Double tap the ☞ symbol                                | Ringing   |
| Hold active call and switch to incoming or held call | Press the + symbol for 1 second                        | Active call with ringing incoming call or held call |
| End active call and answer a new incoming call       | Press the - symbol for 1 second                        | Active call with ringing incoming call              |
| Reset the S4   | Press the + and - symbols together for about 6 seconds | Idle (not connected to any phones)                  |

## Phone Specific Tips and Tricks

### Android

- > Please note that voice dialing over Bluetooth was added to the Android Operating System in version 2.2. It will not be possible to use **Phone Commands** unless your Android device is running Android OS 2.2 or higher.
- > On some Android phones a warning message about the phonebook transfer appears in the top left corner. You must select this message and agree to the connection in order to copy the phonebook to the S4.

### Apple® iPhone®

- > Please note that voice control over Bluetooth was introduced on the Apple iPhone 3GS in firmware version 3.1. Older versions of the Apple iPhone do not support voice dialing over Bluetooth, so it will not be possible to use **Phone Commands** on these devices.
- > When you transfer your phonebook to the S4 from the Apple iPhone, the order in which the names will be read out is determined by a setting on the phone.

If you find that the caller's last name is read out first followed by the caller's first name then you should go

to the “Mail, Contacts, Calendars” section in the “Settings” menu on your phone and change both the “Sort Order” and “Display Order” to “First, Last”. Once you have changed this setting, you must use the **Update Phonebook** command to copy the phonebook to the S4 again.

## BlackBerry

- When pairing your S4 with a BlackBerry device, you may be prompted to allow the connection from the S4 in order to transfer your phonebook. If you see a message asking if you want to connect to the S4 or allow a phonebook transfer, choose “Yes” and ensure that “Always allow this connection” or “Don’t ask this again” is also selected.
- If you find that your S4 does not reconnect to your phone, go to the “Options” menu and ensure that the S4 is configured as a “Trusted Device”.

## Other Models

For tips and tricks for other phone models, please see our support knowledgebase on [www.blueantwireless.com](http://www.blueantwireless.com)

## Troubleshooting

### I Cannot Transfer my Phonebook to the S4

In order to transfer your phonebook to the S4, your phone must support either the Phonebook Access Profile (PBAP), AT commands, or the Object Push Profile (OPP). If your phone does not support any of these Bluetooth profiles, then you will not be able to copy your contacts to the S4. When you receive a call, the S4 will read out the caller's number instead.

Some phones support phonebook transfers but do not support doing them automatically. If this is the case on your phone then you will need to manually send the contacts to the S4, as described in **[“Manually Transferring your Phonebook Contacts to the S4” on page 18.](#)**

If you are having problems transferring your phonebook to the S4, please see our knowledgebase on **[www.blueantwireless.com](http://www.blueantwireless.com)**. This contains extensive troubleshooting tips for phone-specific issues relating to the phonebook transfer process.

### Names Announced in the Wrong Order (Last Name, First Name)

Depending on how your phone is configured, you may find that the S4 reads out names the wrong way round.

If this is happening, you can resolve it by changing the setting on your phone that controls the display and sort order of your contacts.\*

The exact setting to change depends on your phone. For example, Apple iPhone users should go to the “Mail, Contacts, Calendars” section in the “Settings” menu and change both the “Sort Order” and “Display Order” to “First, Last”.

After changing the setting, you **must** use the **Update Phonebook** command to update the contacts on your S4.

\* Some phones do not allow you to adjust the order. If this is the case the S4 will read the names in whatever order it receives from the phone.

## The S4 Does Not Announce the Caller's Name

The S4 will only announce the name if the caller's name and number are stored in your phonebook and have been transferred to the S4 (on most phones your phonebook is automatically transferred when you pair your phone).

If you add a number to your phonebook after pairing, then the S4 will not read out the name associated with this number unless you use the **Update Phonebook** command to update the phonebook details on the S4.

The S4 will not read out the caller's name or number if the caller withholds their number.

## The S4 Reads Out the Wrong Name

If the S4 is reading out the wrong name then it is likely that you have changed the contacts in your phone without updating the contacts on the S4. If you make any changes to your phonebook, use the [Update Phonebook](#) command to copy these changes to the S4.

## How Many Contacts Can I Store on the S4?

The S4 can store up to 2,000 phone numbers for each paired device.

Each number stored in your phonebook counts towards this limit. For example, if you have a business, home, and mobile number stored for one of your contacts, then this counts as 3 separate entries.

## The S4 Does Not Respond to “BlueAnt Speak To Me”

If you are having trouble getting the S4 to respond to your voice, it may be that there is too much noise around you for the S4 to hear you. For example, if you have the car radio at a very high volume, this may interfere with the operation of the handsfree trigger.

The handsfree trigger only works when the green handsfree trigger indicator light is on. If the green light is off, tap the  symbol to activate the S4, instead of saying the trigger phrase.

## My Phone Prompts me for a Code when I Pair the S4

Enter the code **0000** (four zeros).

## My Phone Prompts me to Confirm the Connection to the S4

If your phone always prompts you to confirm whether you want to accept the connection from the S4, then you should configure your phone to treat the S4 as a “trusted connection” or a “trusted device”.

The exact option to change will depend on your phone model, but you need to go to the Bluetooth menu and locate the S4 in the list of paired devices, then configure the S4 to be an “authorized device” or add it to your phone’s list of “trusted devices” or “trusted connections”. If your phone has an option to “always allow” the connection or “don’t ask again”, select this option.

## The S4 Switches Itself Off

If the battery gets very low, the S4 will switch itself off automatically. You should charge the S4 using the supplied USB cable and adaptor.

## The S4 Does Not Respond to my Voice Commands

If you are having trouble getting the S4 to respond to your voice commands, try the following tips:

- > Say your command as soon as possible after the S4 asks you to **Say A Command**.
- > When you have an incoming call, you must wait for the S4 to finish asking you if you want to **Answer** or **Ignore** the call before saying the command.
- > Make sure you say the command clearly, speaking at a consistent speed.
- > If the S4 does not respond, repeat the command.
- > Speak louder than any background noise.
- > Try changing the S4's sensitivity level. This setting determines how precisely the words that you say need to match the speech patterns that the S4 has been configured to recognize. You can change it by using the **Sensitivity Level** command.

## The S4 Played a Tone

The S4 plays tones to let you know when certain things happen. If the S4 played a tone, then one of the following has happened:

- > If you take the S4 out of range of your phone, then it will play a tone to indicate that it is no longer connected.
- > The S4 plays a tone when you end a call.
- > The S4 plays a call waiting tone if you receive an incoming call while you are on a call.

## The S4 Light is Distracting

By default the Bluetooth indicator will flash blue at regular intervals to indicate that the S4 is switched on. If you prefer, you can switch this light off. You might want to turn off the light if you find it distracting, for example if you are using the S4 while driving at night.

When you turn the LEDs off, they will still light up when you turn the S4 on and off, but not at other times.

To turn the lights off or back on again, use the **LED Light** command.

## Resetting the S4

If you are having problems with the S4, you can reset it and start again.

Resetting the S4 will clear all the stored pairing settings on the S4, delete any stored contact details and put the device back into pairing mode.

To reset the S4:

1. Delete any existing pairing information from your phone and turn it off and back on again to refresh the phone memory.
2. Make sure the S4 is switched on but not connected to any phones.
3. Press and hold the + and - symbols for about 6 seconds, until the S4 announces that it has been reset.
4. Now turn the S4 off and back on again.

You will now need to pair your phone with the S4 again.

## Specifications

- > Bluetooth version 2.1 + EDR
- > Supported Profiles: HFP 1.5, A2DP 1.2
- > Operating Range: Up to 10 meters
- > Frequency: 2.4 GHz

- > Talk Time: Up to 20 hours
- > Standby Time: Up to 700 hours with handsfree trigger in battery saving mode
- > Charging Time: 3 - 4 hours
- > Battery Type: Rechargeable Lithium Ion

## Help and Support

If you are having trouble getting the S4 to work, please visit [www.blueantwireless.com](http://www.blueantwireless.com) for online help, support, and troubleshooting tips.

You can also follow the links to register your S4 for access to firmware upgrades.

Please call us before returning the S4 to a store and we will help you through any difficulty you may have.

> North America: 1 866 891-3032

> Australia: 1300 669 049

> New Zealand: 0800 443 122



## Terms and Conditions

By using this product, you are agreeing to BlueAnt's terms and conditions, available at [www.blueantwireless.com](http://www.blueantwireless.com) and on the supplied warranty information card.

**Please protect your ears.** All BlueAnt devices are designed to reach volumes of up to 100 decibels. Prolonged use at high volumes may affect your hearing capacity and may result in noise induced hearing loss (NIHL). Please read the enclosed safety card for information about the safe use of BlueAnt products.

The Bluetooth® word mark and logos are registered trademarks owned by Bluetooth SIG, Inc. and any use of such marks by BlueAnt Wireless is under license.

Android is a trademark of Google Inc., Apple and iPhone are trademarks of Apple Inc., registered in the U.S. and other countries. The Trademark BlackBerry® is owned by Research In Motion Limited and is registered in the United States and may be pending or registered in other countries. BlueAnt Wireless is not endorsed, sponsored, affiliated with or otherwise authorized by Research In Motion Limited.

BlueAnt and other trademarks are trademarks of BlueAnt and other organizations and may not be used without permission. The BlueAnt logo is registered in the U.S. Patent and Trademark Office and globally with the World Intellectual Property Organization under the Madrid protocol.

© 2010 BlueAnt Wireless. All Rights Reserved.







BlueAnt®

[www.blueantwireless.com](http://www.blueantwireless.com)

North America  
1866 891 3032

Australia  
1300 669 049

New Zealand  
0800 443 122

Email Enquiries  
[customercare@blueantwireless.com](mailto:customercare@blueantwireless.com)