

# WILSON PRO 1050

In-Building Cellular Signal Booster  
With In-Line Amplification



## User Manual

**NEED HELP?**

 [wilsonpro.com](http://wilsonpro.com)

 866.294.1660

---

# Index

Package Content .....	1
About The WilsonPro 1050 System .....	2
Key Features .....	4
Competitive Advantages .....	5
Post Install Setup .....	7
1050 Main Status Screen .....	8
1050 In-Line Status Screens .....	10
Safety Guidelines .....	12
Warranty .....	17

---

# Package Content

## Kit 460230



WilsonPro 1050  
Two-Part Booster  
System



Wide Band Directional  
Antenna + 75'  
Wilson 400 Cable



Dome Antenna +  
100' Wilson 400 Cable



100' Wilson  
400 Cable



Pair of 2-Way  
Radios



2' Wilson  
400



Lightning Surge  
Protector

# WilsonPro 1050 System

## FCC Approved In-Line Amplification

Compensates for up to 300' of indoor cable losses using in-line amplification.



## Onboard Software For Better Control

Automatically controlled with onboard software, ensuring great connectivity throughout large spaces and multi-story buildings.

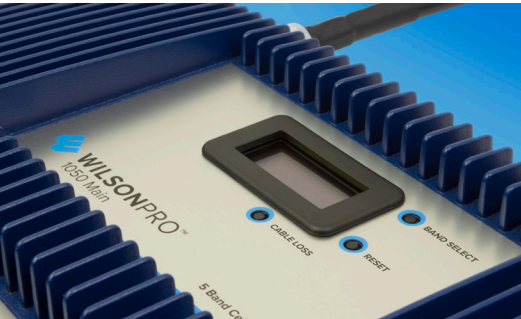

## Extended Dynamic Range For Continuous Connectivity

XDR allows the booster system to never shutdown due to too strong of a signal. No matter how strong, the booster system will never overpower and shutdown.

# XDR TECHNOLOGY

## Auto-Calibration

Main booster & In-Line booster automatically link, communicate & calibrate.

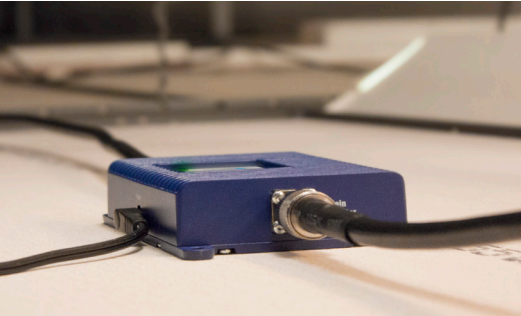

# In-Line Amplification

The WilsonPRO 1050 Cellular Signal Booster System automatically compensates for signal loss resulting from a long indoor RF coax cable run. Simply connect the 1050 In-Line unit at a cable length between 100' and 300' from the 1050 Main unit. When both units are powered up, they will begin to



communicate with each other, sending signals and calculating the amount of signal loss in the cable. Once cable losses are calculated, the gain levels are adjusted between the 1050 Main and 1050 In-Line units so that only enough extra gain is added to the system to compensate for the signal loss of the indoor cable.

This capability to overcome significant cable losses allows the 1050 System to provide cellular coverage in areas that were previously impossible, such as the lower floors of apartment buildings and other multi-dwelling units.

The WilsonPro 1050 system also includes Wilson Electronics' state-of-the-art XDR (Extended Dynamic Range) technology that prevents signal overload conditions which can, in accordance with FCC regulations, force a booster to shut down or even shut down.

When the WilsonPro 1050 system senses that any incoming cell signal is too strong, and threatens to overload the system, XDR automatically reduces signal gain to compensate for this overload condition while maintaining signal coverage throughout the building. In contrast, competing signal boosters shut down when they reach a maximum incoming signal strength threshold, causing the indoor cell signal to drop out. Both antenna ports are located on the top of the 1050 Main unit for easy installation. Like all WilsonPro cell signal boosters, the WilsonPRO 1050 Cellular Signal Booster System is universal: it works for all cellular devices, all services including 4G LTE, and all U.S. and Canada cell phone carriers.

---

# Key Features



**FCC Approved In-Line Amplification:** Compensates for up to 300' of indoor cable losses using in-line amplification, providing cell coverage to hard-to-reach areas.



**Onboard Software for Better Control:** Booster is automatically controlled with automatic onboard software, ensuring great connectivity throughout large spaces and multi-story buildings. The booster will adjust its gain level up or down as required by the conditions of the immediate signal environment.



**Extended Dynamic Range (XDR) for continuous connectivity:** Gives the 1050 much greater tolerance for a strong incoming signal from the tower. XDR lets the 1050 system work with an incoming signal stronger than any competing booster and never shuts down due to a strong outside signal.



**Automatic Calibration:** Main booster and In-Line booster automatically link, communicate, and calibrate.

---

# Competitive Advantages



**Highest Downlink Power:** Up to +15dB more downlink power than the competition allows for stronger signal in environments where the incoming signal is weak. The benefit is a stronger signal sent to the inside antennas, providing larger coverage area from a single booster.



**Highest Uplink Power:** This allows for a stronger signal transmitted to the tower, up to +3dB more than the competition, providing greater user capacity and increased range from the cell site.



**Lower Overload and Shutdown Threshold:** No matter how strong the outside signal, the WilsonPro 1050 system never shuts down. This is a huge benefit in strong signal environments like cities and locations close to a carrier tower.



**Intelligent Control:** WilsonPro cellular boosters automatically adjust signal gain while still providing even signal coverage throughout the building.



**Sophisticated Software:** Cellular signals are constantly fluctuating. The software is always monitoring signal levels and making immediate adjustments as needed, allowing the booster to operate at maximum gain consistently.

# Installation Diagram

A Wilson Lightning Surge Protector is recommended for all building installations. Make sure the protector is installed outside the building at point of entry connected to a suitable ground and in line between the Outside Antenna and the Signal Booster.

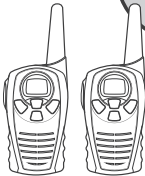
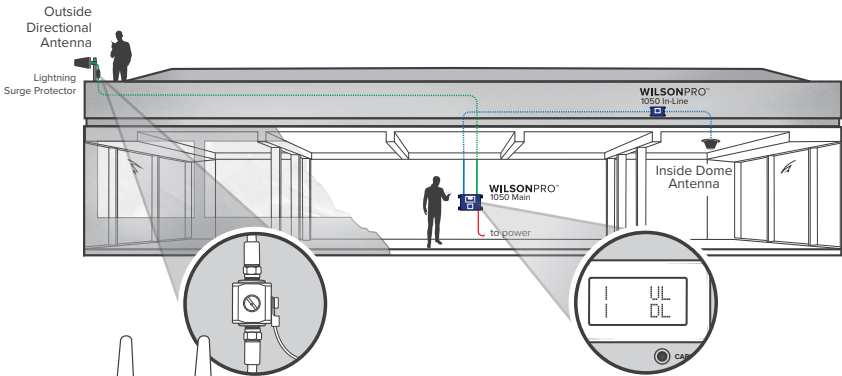

2-way radios are included to help with the installation process.

The direction of the outside antenna should be adjusted until the “DL” bar is maximized.

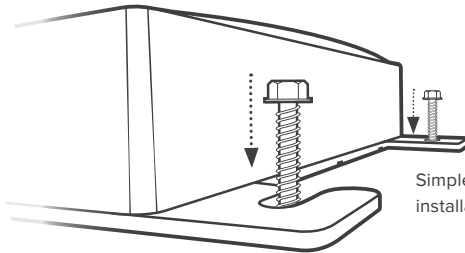

Simple wall-mount installation.



---

# Post Install Setup

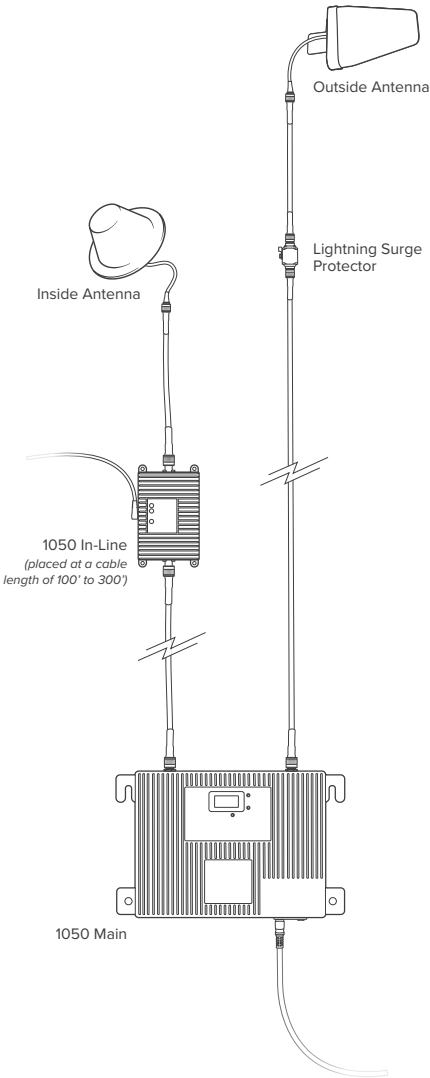

The WilsonPRO 1050 System is designed with advanced internal programming, which allows it to automatically adjust for a variety of conditions, while still boosting weak signals.

Once the AC power cable and antenna cables are connected, turn the unit on by toggling the power switch located near the AC power receptacle.

---

# 1050 Main Status Screen

Upon power up, the 1050 MAIN unit will attempt to begin its calibration routine, which lasts approximately 14 seconds during which time one of the following messages will appear on the screen:



## In-Line Found Screen

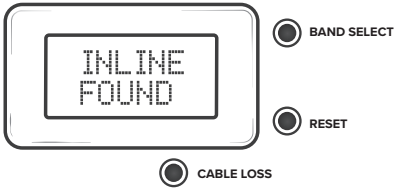

The 1050 In-Line unit has been found and is communicating with the 1050 Main. Cable loss calibration is in progress.

## No In-Line Screen

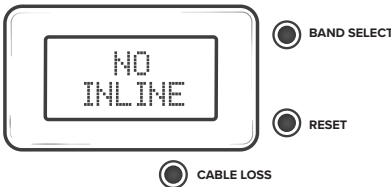

The 1050 In-Line unit has been found and is communicating with the 1050 Main. Cable loss calibration is in progress.

## Failed Calibration Screen

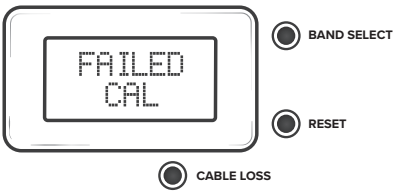

Failed cable loss calibration. Cable loss must be between 4dB and 25dB for all bands. If the cable loss is calculated to be outside of this range, calibration will fail.

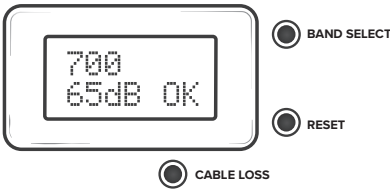

Once cable calibration has successfully completed, the band status screens will appear.

## Cable Loss Button

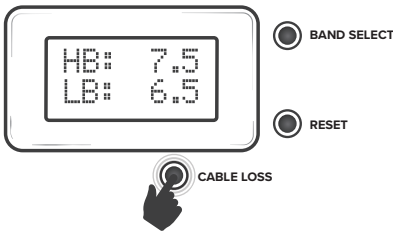

Pressing the Cable Loss Button will display the cable losses at the upper bands and lower bands.

---

# 1050 In-Line Status Lights

The 1050 In-Line has 3 status lights:

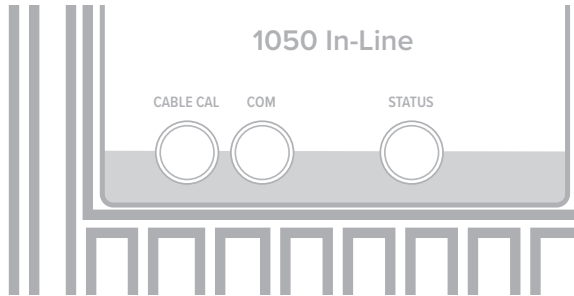

## ‘STATUS’ LED:

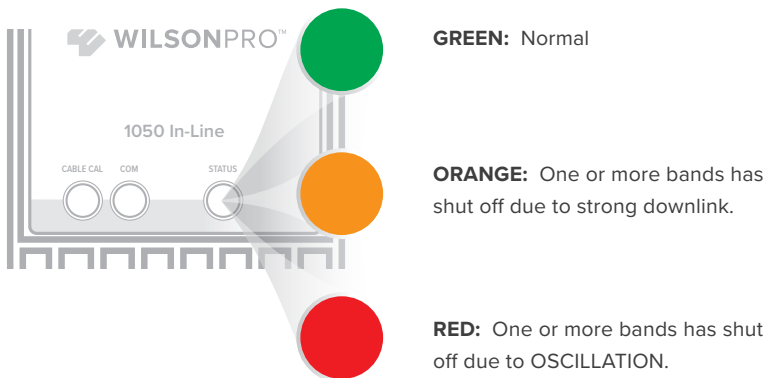

---

## 1050 In-Line Status Screen (cont.)

### 'COM' LED:

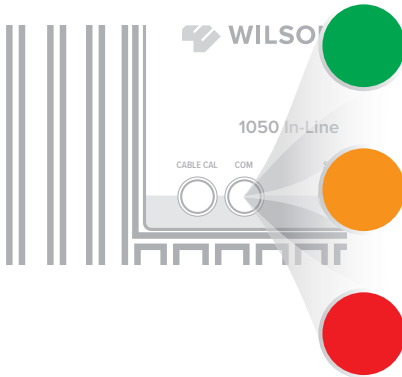

**GREEN:** Normal, waiting for next communications event

**ORANGE:** Brief orange blink when communicating with 1050 Main.

**RED:** Communications failure when attempting to communicate with 1050 Main.

### 'CABLE CAL' LED:



**GREEN:** Calibration complete.

**ORANGE:** Calibration in process.

**RED:** Calibration failed.

---

# Safety Guidelines

## Warnings

To uphold compliance with network protection standards, all active cellular devices must maintain at least 6 feet of separation distance from Panel and Dome antennas.

Use only the power supply provided in this package. Use of a non-Wilson Electronics product may damage your equipment.

The Signal Booster unit is designed for use in an indoor, temperature-controlled environment (less than 100 degrees Fahrenheit). It is not intended for use in attics or similar locations subject to temperatures in excess of that range.

RF Safety Warning: Any antenna used with this device must be located at least 8 inches from all persons.

AWS Warning: Warning: The Outside Antenna must be installed no higher than 10 meters (31'9") above ground.

### This is a **CONSUMER** device.

**BEFORE USE**, you meet all requirements set out in CPC-2-1-05.

**BEFORE USE**, you **MUST REGISTER THIS DEVICE** with your wireless provider and have your provider's consent. Most wireless providers consent to the use of signal boosters. Some providers may not consent to the use of this device on their network. If you are unsure, contact your provider.

You **MUST** operate this device with approved antennas and cables as specified by the manufacturer. Antennas **MUST** be installed at least 20 cm (8 inches) from any person.

You **MUST** cease operating this device immediately if requested by the FCC or a licensed wireless service provider.

**WARNING.** E911 location information may not be provided or may be inaccurate for calls served by using this device.

This device may be operated **ONLY** in a fixed location for in-building use.

This device complies with Part 15 of FCC rules. Operation is subject to two conditions: (1) This device may not cause harmful interference, and (2) this device must accept any interference received, including interference that may cause undesired operation. Changes or modifications not expressly approved by weBoost could void the authority to operate this equipment.

---

## FOR MORE INFORMATION ON REGISTERING YOUR SIGNAL BOOSTER WITH YOUR WIRELESS PROVIDER, PLEASE SEE BELOW:

**Sprint:** [http://www.sprint.com/legal/fcc\\_boosters.html](http://www.sprint.com/legal/fcc_boosters.html)

**T-Mobile/MetroPCS:** <https://support.t-mobile.com/docs/DOC-9827>

**Verizon Wireless:** <http://www.verizonwireless.com/wcms/consumer/register-signal-booster.html>

**AT&T:** <https://secure45.securewebsession.com/attsignalbooster.com/>

**U.S. Cellular:** <http://www.uscellular.com/uscellular/support/fcc-booster-registration.jsp>

# Antenna Kit Options

The following accessories are certified by the FCC to be used with the **Wilson PRO 1050 System**.

## Inside Antenna Expansion Kit

**Kit 309900-50N40090**  
2 - Wall Panel antennas  
1 - 50 ohm 3-Way Splitter  
1 - 100' Wilson 400

**Kit 309905-50N17420**  
3 - Wall Panel Antennas  
3 - 2-Way 50 Ohm Splitters  
20' RG174

**Kit 309902-75F0650**  
2 - Wall Panel Antennas  
1 - 3-Way 75Ohm Splitter  
50' RG6

**Kit 309903-75F1180**  
3 - Wall Panel Antennas  
3 - 2-Way 75Ohm Splitters  
80' RG11 cable

**Kit 309904-75F5830**  
1 - Wall Panel Antenna  
1 - 2-Way 75 Ohm Splitter  
30' RG58 cable

## Inside Antenna Kits

**Kit 311155-0670**  
75 Ohm Wall mount Panel Antenna  
70' RG6 Cable

**Kit 311135-5840**  
50 Ohm Wall mount Panel Antenna  
40' RG58 Cable

**Kit 311135-400150**  
50 Ohm Wall mount Panel Antenna  
150' Wilson 400

**Kit 311155-11120**  
75 Ohm Wall mount Panel Antenna  
10' RG11 cable

**Kit 304412-400100**  
50 Ohm 4G Dome Antenna  
100' Wilson400 cable

**Kit 304412-5830**  
50 Ohm 4G Dome Antenna  
30' RG58 cable

**Kit 304419-1175**  
75 Ohm 4G Dome Antenna  
75' RG 11 cable

**Kit 304419-17450**  
75 Ohm 4G Dome Antenna  
50' RG174 cable  
May need separate adapter

**Kit 304419-0650**  
75 Ohm 4G Dome Antenna  
50' RG6 cable

## 50 Ohm Outside Antenna Kits

**Kit 314453-5825**  
50 Ohm Pole Mount Panel Antenna  
25' RG58 Cable

**Kit 314411-5825**  
50 Ohm Wide Band Directional  
25' RG58 Cable

**Kit 301111-5850**  
Yagi Directional Antenna  
50' RG58 Cable

**Kit 311203-5820**  
Omni-Directional antenna  
20' RG58 Cable

**Kit 314411-40075**  
50 Ohm Wide Band Directional  
75' LMR400 Cable

**Kit 311203-40020**  
Omni-Directional antenna  
20' LMR400 Cable

**Kit 301111-400170**  
Yagi Directional w/ N-Female  
170' LMR400

**Kit 314453-40075**  
50 Ohm Pole Mount Panel Antenna  
75' LMR400 Cable

**Kit 304422-40020**  
50 Ohm 4G Omni Antenna  
20' Wilson400 cable

**Kit 304422-5810**  
50 Ohm 4G Omni Antenna  
10' RG58 cable

**Kit 304422-1120**  
50 Ohm 4G Omni Antenna  
20' RG11 cable  
May need separate adapter

## 75 Ohm Outside Antenna Kits

**Kit 301111-0675**  
Yagi Directional Antenna  
75' RG6 Cable  
N-Male to F-Female adapter

**Kit 311201-0620**  
Omni Directional w/ F-Female  
20' RG6 Cable

**Kit 314473-0640**  
75 Ohm Pole Mount Panel Antenna  
40' RG6 Cable

**Kit 311141-0620**  
75 Ohm Grey Brick Antenna  
20' RG6 Cable

**Kit 301111-11140**  
Yagi Directional Antenna  
140' RG11 Cable  
N-Male to F-Female adapter

**Kit 31201-1120**  
Omni Directional w/ F-Female  
20' RG11 Cable

**Kit 314473-1175**  
75 Ohm Pole Mount Panel Antenna  
75' RG11 Cable

**Kit 314475-0630**  
75 Ohm Wide Band Directional  
30' RG6 Cable

**Kit 314475-1175**  
75 Ohm Wide Band Directional  
75' RG11 Cable

**Kit 311141-1120**  
75 Ohm Grey Brick Antenna  
20' RG11 Cable

**Kit 304421-17410**  
75 Ohm 4G Omni Antenna  
10' RG174 cable

**Kit 304421-0610**  
75 Ohm 4G Omni Antenna  
10' RG6 cable

**Kit 304421-5810**  
75 Ohm 4G Omni Antenna  
10' RG58 cable  
May need separate adapter

**Kit 304421-1120**  
75 Ohm 4G Omni Antenna  
20' RG 11 cable

# Specifications

<b>Product Number</b>	460030				
<b>Model Number</b>	460030				
<b>FCC ID</b>	PWO460030 / PWO0460030IL				
<b>IC ID</b>	4726A-460030				
<b>Connectors</b>	N-Female				
<b>Antenna Impedance</b>	50 Ohms				
<b>Frequency</b>	698-716 MHz, 729-746 MHz, 777-787 MHz, 824-894 MHz, 1850-1995 MHz, 1710-1755/2110-2155 MHz				
<b>Power output for single cell phone (Uplink) dBm</b>	<b>700MHz Band12/17</b>	<b>700MHz Band13</b>	<b>800MHz</b>	<b>1700MHz</b>	<b>1900MHz</b>
	24.7	24.7	24.3	25.1	24.5
<b>Power output for single cell phone (Downlink) dBm</b>	<b>700MHz Band12/17</b>	<b>700MHz Band13</b>	<b>800MHz</b>	<b>2100MHz</b>	<b>1900MHz</b>
	14.8	14.3	15.2	15	15.1
	<b>1050 Main</b>			<b>1050 In-Line</b>	
<b>Noise Figure</b>	5 dB nominal			5 dB nominal	
<b>Isolation</b>	> 90 dB			> 90 dB	
<b>Power Requirements</b>	110-220V AC			5V 3A	

The term "IC" before the radio certification number only signifies that Industry Canada technical specifications were met.

Each Signal Booster is individually tested and factory set to ensure FCC compliance. The Signal Booster cannot be adjusted without factory reprogramming or disabling the hardware. The Signal Booster will amplify, but not alter incoming and outgoing signals in order to increase coverage of authorized frequency bands only. If the Signal Booster is not in use for five minutes, it will reduce gain until a signal is detected. If a detected signal is too high in a frequency band, or if the Signal Booster detects an oscillation, the Signal Booster will automatically turn the power off on that band. For a detected oscillation the Signal Booster will automatically resume normal operation after a minimum of 1 minute. After 5 (five) such automatic restarts, any problematic bands are permanently shut off until the Signal Booster has been manually restarted by momentarily removing power from the Signal Booster. Noise power, gain, and linearity are maintained by the Signal Booster's microprocessor.







---

# Warranty

## 30 DAY MONEY-BACK GUARANTEE

All WilsonPro products are protected by WilsonPro 30-day money-back guarantee. If for any reason the performance of any product is not acceptable, simply return the product directly to the reseller with a dated proof of purchase.

## 3 YEAR WARRANTY

WilsonPro Boosters are warranted for three (3) years against defects in workmanship and/or materials. Warranty cases may be resolved by returning the product directly to the reseller with a dated proof of purchase.

Signal Boosters may also be returned directly to the manufacturer at the consumer's expense, with a dated proof of purchase and a Returned Material Authorization (RMA) number supplied by WilsonPro. WilsonPro shall, at its option, either repair or replace the product.

This warranty does not apply to any Signal Boosters determined by WilsonPro to have been subjected to misuse, abuse, neglect, or mishandling that alters or damages physical or electronic properties.

RMA numbers may be obtained by contacting Customer Support.

**DISCLAIMER:** The information provided by WilsonPro is believed to be complete and accurate. However, no responsibility is assumed by WilsonPro for any business or personal losses arising from its use, or for any infringements of patents or other rights of third parties that may result from its use.

---

**NEED HELP?**



[support.wilsonpro.com](https://support.wilsonpro.com)



866.294.1660



3301 East Deseret Drive, St. George, UT  
[www.wilsonpro.com](http://www.wilsonpro.com) | [support.wilsonpro.com](http://support.wilsonpro.com)

Copyright © 2016 Wilson Electronics. All rights reserved.  
Wilson Electronics products covered by U.S. patent(s) and pending application(s)  
For patents go to: [weboost.com/us/patents](http://weboost.com/us/patents)