



**DT4G™**  
**Cellular Signal Booster**  
**460001/460101**



Need help?



[www.WilsonElectronics.com](http://www.WilsonElectronics.com)

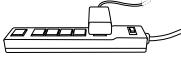

**Tech Support 866-294-1660**  
Mon.- Fri. Hours: 7 am to 6 pm MST

 <p>IT IS VERY IMPORTANT TO POWER YOUR SIGNAL BOOSTER USING A SURGE PROTECTED AC POWER STRIP WITH AT LEAST A <b>1000 JOULE RATING</b>.</p> <p>FAILURE TO DO THIS WILL VOID YOUR WARRANTY IN THE EVENT OF A POWER SURGE OR LIGHTNING STRIKE.</p> 	 <p>THE SIGNAL BOOSTER UNIT IS DESIGNED FOR USE IN AN INDOOR, TEMPERATURE-CONTROLLED ENVIRONMENT (LESS THAN 150 DEGREES FAHRENHEIT). IT IS NOT INTENDED FOR USE IN ATTICS OR SIMILAR LOCATIONS SUBJECT TO TEMPERATURES IN EXCESS OF 150°F.</p>
--	---

**Installation Instructions for the Following Wilson Electronics Signal Booster:**

**DT4G 700 MHz Band 13 & 17, 800 / 1900 (Ext. PCS) AWS (1700 / 2100)**  
**SmartTech III™ Signal Booster**  
 Model # 460001 FCC ID: PWO460001

**Contents**

**Package Contents** . . . . . 3

**Optional Accessories** . . . . . 3

**Before Getting Started** . . . . . 3

**Find the Strongest Signal** . . . . . 4

**Quick Install - Inside Window Mount Option** . . . . . 5

**Installation Options** . . . . . 6

    Outside Pole Mount (Best Option) . . . . . 6

    Outside Wall Mount Option . . . . . 7

    Rafter Mount Option . . . . . 8

**Additional Considerations** . . . . . 8

**DT4G™ and Desktop Antenna Placement** . . . . . 9

**Troubleshooting & Understanding Lights** . . . . . 10

**Additional FAQ** . . . . . 12

**Safety Guidelines & Recommendations** . . . . . 13

**Signal Booster Specifications** . . . . . 15

**Guarantee and Warranty** . . . . . Back Cover



## Package Contents



DT4G



Desktop Antenna  
(5' RG-174 comes attached)  
(301213)



Outside Panel Antenna Kit  
Outside Panel Antenna  
30' RG6 coax cables  
(314473-0630)



30' RG6  
Coax Cable  
(950630)



AC Power Supply  
5V / 2.5A  
(Not included with some models)  
(859948)



Cable  
Connector  
(971129)

Appearance of device and accessories may vary.

### Mounting Option Accessories (Included)

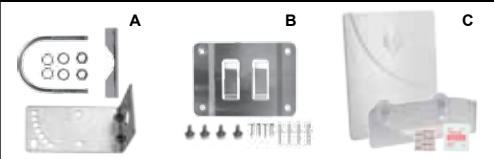

### DT4G Inside Panel Antenna Upgrade

(311155-0630)



Panel Antenna  
w/F-Female Connectors  
RG6 30' Coax Cable  
w/F-Male Connectors  
Required F-Female to SMA  
Male adapter

### Tools Required for Installation:

(depending on your particular installation, you will need the following tools)

1. Pole mount - 10 mm open-end wrench or adjustable wrench
2. Wall mount or Rafter mount - Drill and 3/16 inch bit, Phillips-head screwdriver

## Before Getting Started

Before you install your DT4G™ and start enjoying improved cellular reception in your home or office, please do the following:

1. Read through all the installation steps. This will help you know what to expect from start to finish.
2. Watch the YouTube video demonstrating the DT4G Signal Boost installation at: [wilsonelectronics.com/DT4Gvideo](http://wilsonelectronics.com/DT4Gvideo).
3. Determine the best installation option for your needs.
  - Outside Pole Mount Option - pg.6 (Best Option)
  - Outside Wall Mount Option - pg.7
  - Rafter Mount Option - pg.8
  - Inside Window Mount Option - pg.5
4. Familiarize yourself with all materials in your product package. This will allow you to know which pieces are referenced in the instructions.
5. Identify the location of your best available cellular signal. See page 4.
6. Plan where to mount your antenna.

Need help?



[www.WilsonElectronics.com](http://www.WilsonElectronics.com)



Tech Support 866-294-1660  
Mon. - Fri. Hours: 7 am to 6 pm MST

## Find the Strongest Cellular Signal

Before you install your DT4G signal booster, you must determine the location of the best available cellular signal. This will affect the location of your Outside Antenna and will help you get the best performance from your DT4G. You can find the strongest signal outside your building, typically at the highest point available, using any of the following methods:

### 1. **Best method:**

Connect the Outside Antenna to the DT4G signal booster, and the DT4G to the Desktop Antenna. Have one person outside (on the roof for best results) rotate the Outside Antenna with a second person inside the building near the Desktop Antenna watching the signal strength on a phone. This allows you to read the signal strength from nearby cell towers.

- a. The person inside should have the phone in test mode so the numerical signal strength can be read. This is more accurate than the bar indicator. Go to [www.wilsonelectronics.com/test-mode-instructions](http://www.wilsonelectronics.com/test-mode-instructions) for help in finding the test mode for your phone.
- b. The person on the roof should turn the Outside Antenna 45 degrees at a time. Allow 30 seconds for the phone to register with each turn.

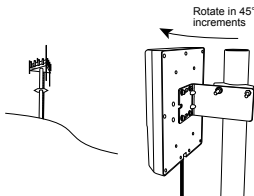

- c. The person inside should note the readings on the phone with each turn. Signal readings usually appear as a negative number. The closer the number gets to zero, the stronger the signal (for example, -86 dB would be a moderately good reading while -55 dB would be an excellent reading, and -110 dB would be a weak, or unusable signal).

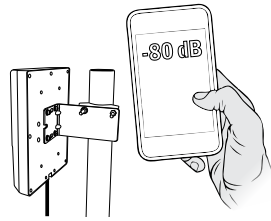

- d. Once you have determined which direction provides the strongest outside signal, you can install the Outside Antenna in that general direction.

### 2. **Good methods:**

- a. Place calls from several locations outside your building. As you move to different locations, note where you get the best reception.
- b. If you have a smart phone, you can download apps that help you identify locations of cell phone towers or the strongest signal. Go to the App Store and search for "cell signal" to find available apps for your device.



3. **Acceptable method:** Check the bar indicator on your cell phone display and note where the signal appears the strongest. (Note: cell phone bars are only an approximation of signal strength and vary from phone to phone.) Phones can take up to 30 seconds to reset to a new reading. Be patient and repeat your signal check several times.

**WAIT 30 SECONDS**



For additional instructions on finding the strongest cellular signal, watch the installation video at: [www.wilsonelectronics.com/DT4Gvideo](http://www.wilsonelectronics.com/DT4Gvideo)



## Quick Install - Inside Window Mount Option

Additional installation options on pg. 6-8

**Find the Strongest Cellular Signal**  
(See page 4 for suggested methods.)

### Ready to Install Inside Window Mount

1. Select a location on the inside of a window as high as possible and at least 20 feet from where the DT4G will be located. Note that this distance typically requires the window mount to be in a different room from where you will locate the DT4G and Desktop Antenna. The window should face roughly in the direction of the strongest cellular signal (see section headed "Find the Strongest Cellular Signal" on page 4).

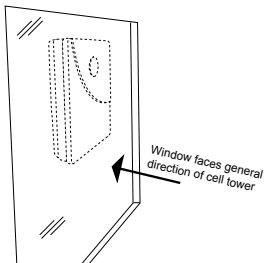

2. Clean the area on the glass with the alcohol prep pad included in Packet C.
3. Insert the suction cups included in Packet C into the holes on the Outside Antenna cradle using a twisting motion. Press the suction cups onto the window in the desired location.

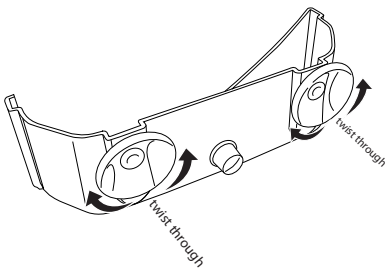

4. Insert the Outside Antenna into the cradle.

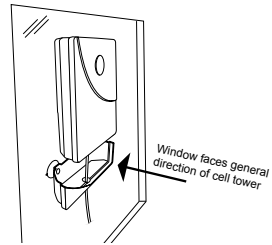

5. Connect the supplied coax cable to the antenna lead cable on the Outside Antenna.

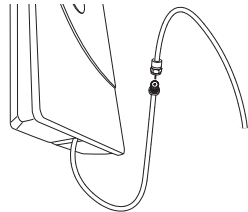

6. Route the cable as desired to the location of the DT4G. If you need to connect both coax cables, use the Cable Connector provided.



7. Connect the coax cable to the DT4G. Connect the Desktop Antenna to the DT4G. For instructions on install and Desktop Antenna placement refer to page 9.

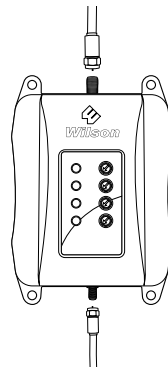

- Connect the DT4G to a surge protected AC power strip with at least a 1000 Joule rating. If your DT4G is working correctly, the lights will be green.

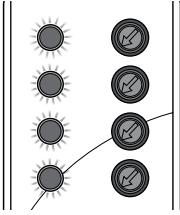

If the lights are orange or red, see the “Troubleshooting” section on page 10.

**NOTE:**

**Modern energy efficient dual-pane windows with coatings will weaken the cellular signals as they pass through because of a metal oxide film applied during manufacturing. If you have dual-pane windows with energy efficient coatings, we recommend one of the other mounting options if your performance is not to your satisfaction.**

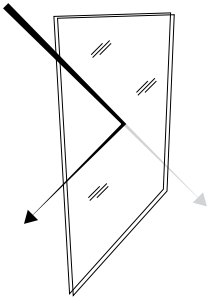

## Installation Options

### Outside Pole Mount Option (Best Option)

- Select a location on the roof where the Outside Antenna can be mounted on a pole maintaining at least 20 feet of vertical or horizontal separation from the inside Desktop Antenna.



Place the desktop signal antenna directly beneath the placement of the Outside Antenna location

At least 20 feet of vertical or horizontal separation from the desktop antenna is needed



- Find an existing pole or obtain a pole of 1 to 2 inches in diameter. Mounting hardware to attach the pole to the roof can be purchased from a hardware store or you can purchase a Wilson’s pole mount accessory kit, part #901117. Install the pole in the desired location.

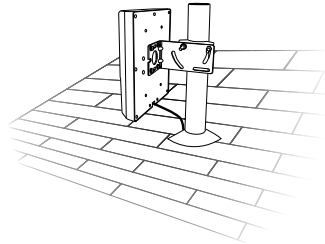

- Using the hardware in Packet A, slide both brackets onto U-bolt. Tighten nut & washers set onto U-bolt.

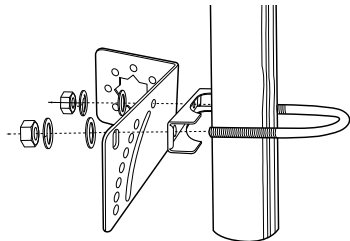

- Fit the assembly onto the pole in your desired location by sliding the second half of the bracket onto the U-bolt and securing it with the lock washers and nuts provided. Be sure the cradle is at the desired height and rotated toward the strongest cellular signal before tightening the nuts. Do not over tighten.

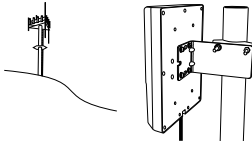

- Connect the supplied coax cable to the antenna lead cable on the Outside Antenna.

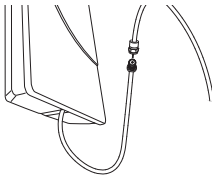

- Route the cable as desired to the location of the DT4G. If you need to connect both coax cables, use the Cable Connector provided. Secure the cable with ties as needed (ties not provided).

## Outside Wall Mount Option

- Select a location on an outside wall as high as possible and at least 20 feet from where the DT4G will be located. The wall should face in roughly the same direction as the strongest cellular signal.

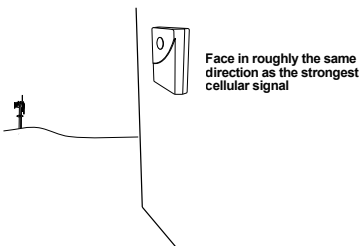

- Position the Outside Antenna bracket, from Packet B, on the wall as a template and mark the screw holes with a pencil.

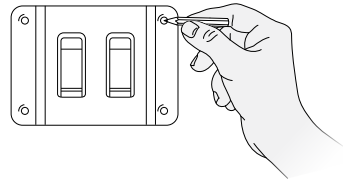

- Drill four holes where you marked, using a 3/16-inch bit. Insert the plastic screw anchors provided in Packet B.

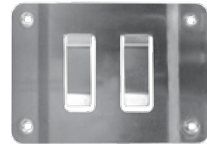

Outside Antenna bracket

- Line up the Outside Antenna bracket with the screw anchors. Mount the cradle antenna bracket to the wall using the four screws and four washers provided in Packet B.

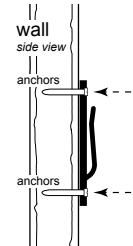

- Connect the supplied coax cable to the antenna lead cable on the Outside Antenna.

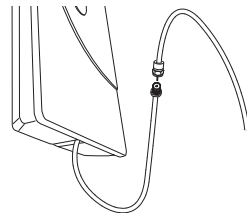

- Route the cable as desired to the location of the DT4G. If you need to connect both coax cables, use the Cable Connector provided.



## Rafter Mount Option

1. Select a location in the building's rafters where the Outside Antenna can be mounted directly above the Desktop Antenna with at least 20 feet vertical or horizontal separation. The location should allow you to mount the Outside Antenna roughly in the direction of the strongest cellular signal.

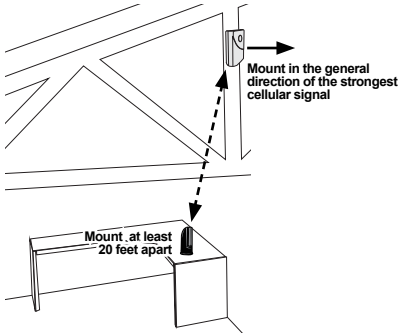

2. Mount the Outside Antenna bracket to the rafter using the four screws and four washers provided in Packet B (pre-drill if necessary.)

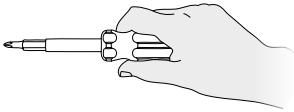

3. Connect the supplied coax cable to the antenna lead cable on the Outside Antenna.

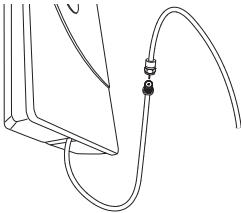

4. Route the cable as desired to the location of the DT4G. If you need to connect both coax cables, use the Cable Connector provided.



## Additional Considerations

Whichever installation you choose, keep the following guidelines in mind to maximize your signal strength:

1. Always turn the Outside Antenna so the Wilson logo is toward the strongest cellular signal. The strength of the signal at the Desktop Antenna (and therefore, how far it will transmit a signal) is dependent upon the signal strength at the Outside Antenna. Be sure to maximize the strength at the Outside Antenna.

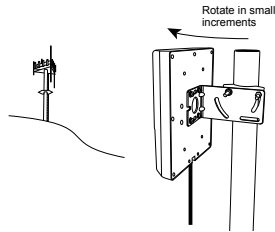

2. Maintain a distance of at least 20 feet from the Outside Antenna to the DT4G unit.



If possible, place the Desktop Signal Antenna directly beneath the placement of the Outside Antenna location. This creates a maximized signal zone within the room where the Desktop Antenna remains.



Place the desktop signal antenna directly beneath the placement of the Outside Antenna location

At least 20 feet of vertical or horizontal separation from the desktop antenna is needed





- Keep the DT4G and the Desktop Antenna **at least 18 inches away** from each other with the Wilson logo on the Desktop Antenna facing away from the DT4G.

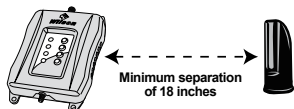

- Do not face the Outside Antenna and the Desktop Antenna toward each other. This can cause the DT4G to show red lights and shut down, preventing oscillation or feedback (see troubleshooting on pg. 13). In other words, the Wilson logos on the Outside Antenna and the Desktop Antenna should always be facing away from each other.



- If you do not know how to mount hardware or run coax cable through walls, ceilings and floors, get help from one of Wilson's certified installers at [www.wilsonelectronics.com/installers](http://www.wilsonelectronics.com/installers) or from a qualified contractor or electrician. You can also try the Inside Window Mount option (pg.5), which may be sufficient for your needs.

**Recommended: Lightning Surge Protector (Sold Separately, part #859992)**

We recommend you install the Lightning Surge Protector (LSP) close to the DT4G. Attach the cable from the Outside Antenna to the surge protector and ground the surge protector. The LSP is sold separately.

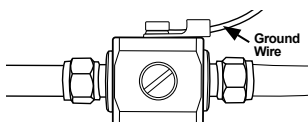

**DT4G and Desktop Antenna Placement**

- Select a location for the DT4G that is away from excessive heat, direct sunlight, and moisture and has proper ventilation. Recommended locations include on a shelf, in a closet, on a desk or behind it. Be sure the location is near a power outlet. To ensure proper ventilation, keep other objects at least six (6) inches away.
- Place the DT4G on a desk, table or other solid surface where you have routed the cable from the Outside Antenna.

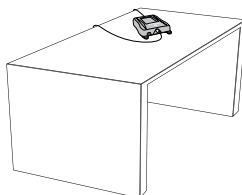

- Attach the coax cable from the Outside Antenna to the DT4G at the connector labeled "Outside Antenna."

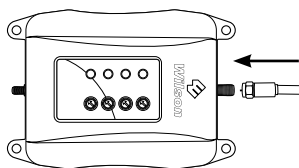

- Attach the Inside Antenna to the connector labeled "Inside Antenna."

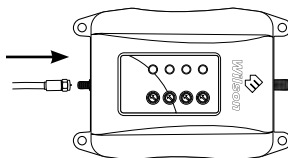

- Ensure the Inside Antenna is facing away from both the DT4G and the Outside Antenna.

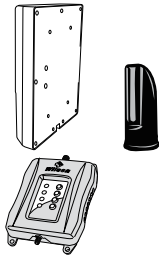

**Note**  
Face Inside Antenna  
away from DT and  
Outside Antenna

- Plug in the power supply to the DT4G at the input marked "Power" (next to the "Outside Antenna" connector). Plug the power supply into a surge protected AC power strip with at least a 1000 Joule rating.

**Important notice:** Connect your DT4G AC Power Supply to a surge protected AC power strip with at least a 1000 Joule rating. Failure to do this will **void your warranty** in the event of a power surge or lightning strike.

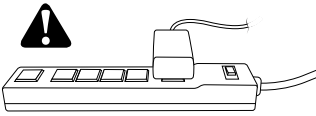

- Check the lights on top of the DT4G. 4 green lights mean you have good signal. If you do not have green lights, see the following Troubleshooting Tips.

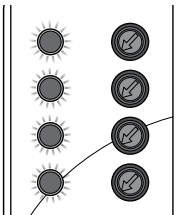

## Troubleshooting & Understanding Lights

The DT4G includes four indicator lights, one for each band (for more information about the frequency bands used by your cell service provider visit [wirelessadvisor.com](http://wirelessadvisor.com).) All indicator lights will be green, orange or red.

**Green** indicates the unit is powered and working properly. You always want the lights to be green.

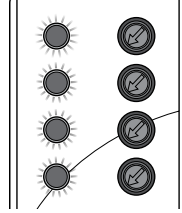

**Red** indicates the DT4G has shut down to prevent oscillation (feedback).

**Orange** indicates the DT4G is overloaded because it is too close to a cell tower.

**Note:** All red light issues must be resolved **before** orange light issues.

### Fixing Red Light Issues

If any lights on the DT4G are red or blinking red try 1 or more of the following:

- Make sure all connections are tight.
- Reduce the gain of the DT4G by rotating the gain control knob corresponding with the red light. This is done by turning the knob counter-clockwise in small increments, waiting 5 seconds between each adjustment for the DT4G to reset. Continue this adjustment until the light turns green.

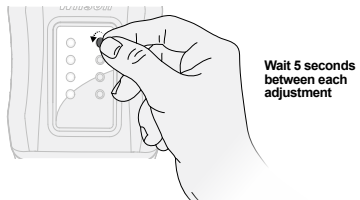

**IMPORTANT NOTE:** Reducing the gain decreases the inside coverage area. If the amount of coverage area is sufficient when the green light comes on, your installation is complete.

- c) You need to increase the distance between the Outside Antenna and the Desktop Antenna by moving them horizontally and/or vertically farther apart making sure they are not facing towards each other.

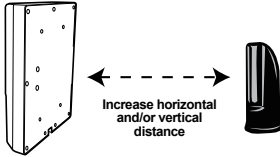

If the light is green after separating the antennas, increase the gain until the red light comes on. Then slightly decrease the gain until the green light appears. This ensures maximum coverage.

- d) If you get too close to the Inside Antenna you may experience reduced signal performance. Increase the distance between the handset and the Inside Antenna until the light is no longer flashing red.
- e) If your coverage area is still too small after separating the antennas, contact the Wilson Electronics Technical Support Team for assistance: 866-294-1660.

**Fixing Orange Light Issues**

If any lights on the DT4G are orange or blinking orange:

- a) Turn down the gain control until you get a green light.

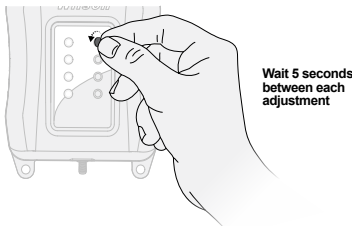

- b) If the gain is not adequate for good coverage, turn the Outside Antenna away from the strongest cellular signal in small increments until the light turns green.

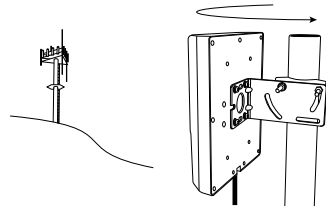

If the lights will not respond, turn the gain down in 5 dB increments and move the Outside Antenna. Continue to adjust the gain and antenna positions until the light turns green.

- c) If the light remains orange or blinking orange, contact the Wilson Electronics Technical Support Team for assistance: 866-294-1660.

**Lights Off**

If one or more of the lights on Signal Booster are off verify power to your surge protected power strip. If power and lights are still off this means that the gain has been turned all the way down and the band is in Power Save Mode. Increase the gain until the light turns on. If there are bands that are not being used in the local coverage area, we recommend turning these frequencies off. This will reduce energy consumption.

NOTE: The DT4G can be reset by disconnecting and reconnecting the power supply.

For additional descriptions on troubleshooting, see the install video at: [wilsonelectronics.com/DT4Gvideo](http://wilsonelectronics.com/DT4Gvideo).



## Additional FAQ:

### What hours can I contact tech support?

Technical Support can be reached from 7:00am to 6:00pm MST, by calling (866-294-1660), or by email, at [tech@wilsonelectronics.com](mailto:tech@wilsonelectronics.com)

### How does weather affect the performance of my Outside Antenna?

Water vapor (e.g. rain, fog, snow or other precipitation) creates an effective filter to cellular signal. In times of heavy precipitation, you may see less performance.

### What's the difference between the 800 MHz and the 1900 MHz bands? How do I know which MHz band my cell phone uses?

The DT4G works with all major North American cellular providers on the 800 & 1900 MHz frequencies. Traditionally, 800/1900MHz are associated with voice and 3G data; while 700MHz and 1700/2100MHz are associated with 4G data. For more detail, refer to [wirelessadvisor.com](http://wirelessadvisor.com)

### Why do I need to maintain at least 20 feet of separation, but no more than 50 feet? OR Why do I need to create so much distance between the antennas?

Antennas connected to a booster create a sphere of signal. When these spheres overlap, a condition called oscillation occurs. This oscillation can be thought of as noise, which causes the booster to shut down to prevent damage from occurring. The best way to keep these spheres of signal from creating noise is to maintain separation between your inside and Outside Antennas. However – as any cable has loss, we recommend that you try to minimize the total separation to keep within the range of 20-50 feet.

## United States Carrier Frequency Use

We recommend visiting [www.wirelessadvisor.com](http://www.wirelessadvisor.com) for information regarding the frequency band used by your cell service provider in a specific geographical location.

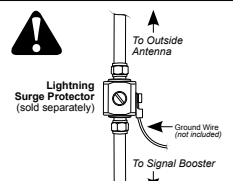







**RECOMMENDED: INSTALLING THE LIGHTNING SURGE PROTECTOR**  
(SOLD SEPARATELY)

INSTALL THE LIGHTNING SURGE PROTECTOR (LSP) CLOSE TO THE SIGNAL BOOSTER. ATTACH THE CABLE FROM THE OUTSIDE ANTENNA TO THE SURGE PROTECTOR. **ENSURE THE LSP IS PROPERLY GROUNDED.** #859992-75 OHM MAY BE PURCHASED AT [WWW.WILSONELECTRONICS.COM](http://WWW.WILSONELECTRONICS.COM) OR BY CALLING 800-204-4104.



## Safety Guidelines

-  **WARNING:** To uphold compliance with network protection standards, all active cellular devices must maintain at least 6 feet of separation distance from Panel and Dome antennas and 4 feet of separation distance from Desktop antennas.
-  **WARNING:** Connecting the Signal Booster directly to the cell phone with use of an adapter will damage the cell phone.
-  **WARNING:** Use only the power supply provided in this package. Use of a non-Wilson Electronics product may damage your equipment.
-  **WARNING:** The Signal Booster unit is designed for use in an indoor, temperature-controlled environment (less than 150 degrees Fahrenheit). It is not intended for use in attics or similar locations subject to temperatures in excess of that range.
-  **WARNING:** The Outside Antenna must be installed no higher than 10 meters (32'9") above ground.
-  **WARNING:** Take care to ensure that neither you nor the pole comes near any power lines during installation.

### This is a CONSUMER device.

**BEFORE USE**, you **MUST REGISTER THIS DEVICE** with your wireless provider and have your provider's consent. Most wireless providers consent to the use of signal boosters. Some providers may not consent to the use of this device on their network. If you are unsure, contact your provider.

You **MUST** operate this device with approved antennas and cables as specified by the manufacturer. Antennas **MUST** be installed at least 20 cm (8 inches) from any person.

You **MUST** cease operating this device immediately if requested by the FCC or a licensed wireless service provider.

**WARNING.** E911 location information may not be provided or may be inaccurate for calls served by using this device.

This device complies with Part 15 of FCC rules. Operation is subject to two conditions: (1) This device may not cause harmful interference, and (2) this device must accept any interference received, including interference that may cause undesired operation. Changes or modifications not expressly approved by Wilson Electronics could void the authority to operate this equipment.





# Signal Booster Specifications

	DT4G Specifications				
Model Number	460001				
Antenna connectors	SMA-male on the Inside Antenna / F-male on the Outside Antenna				
Antenna impedance	50 Ohms				
Dimensions	4.5 x 6.44 x 1.19 in. or 11.43 x 16.35 x 3.02 cm				
Weight	0.4 lbs or 0.18 kg				
Frequency	Frequency 704-746 MHz, 746-787 MHz, 824-894 MHz, 1850-1995 MHz, 1710-1755/2110-2155 MHz				
Power output for a single phone (uplink) dBm	Maximum Power				
	700 MHz Band 17	700 MHz Band 13	800 MHz	1900 MHz	1700 MHz
	23.7	23.6	24.6	23.3	24.9
Power output for a single received channel (downlink) dBm	Maximum Power				
	700 MHz Band 17	700 MHz Band 13	800 MHz	1900 MHz	2100 MHz
	0.9	-1.0	2.1	6.1	5.8
Noise Figure (typical downlink/uplink)	7 dB nominal				
Power Requirements	110-240 V AC, 50-60 Hz, 8 W				

Each Signal Booster is individually tested and factory set to ensure FCC compliance. The Signal Booster cannot be adjusted without factory reprogramming or disabling the hardware. The Signal Booster will amplify, but not alter incoming and outgoing signals in order to increase coverage of authorized frequency bands only. If the Signal Booster is not in use for five minutes, it will reduce gain until a signal is detected. If a detected signal is too high in a frequency band, or if the Signal Booster detects an oscillation, the Signal Booster will automatically turn the power off on that band. For a detected oscillation the Signal Booster will automatically resume normal operation after a minimum of 1 minute. After 5 (five) such automatic restarts, any problematic bands are permanently shut off until the Signal Booster has been manually restarted by momentarily removing power from the Signal Booster. Noise power, gain, and linearity are maintained by the Signal Booster's microprocessor.



### 30-Day Money-Back Guarantee

All Wilson Electronics products are protected by Wilson Electronics 30-day money-back guarantee. If for any reason the performance of any product is not acceptable, simply return the product directly to the reseller with a dated proof of purchase.

### 2-Year Warranty

Wilson Electronics Signal Boosters are warranted for two (2) years against defects in workmanship and/or materials. Warranty cases may be resolved by returning the product directly to the reseller with a dated proof of purchase.

Signal Boosters may also be returned directly to the manufacturer at the consumer's expense, with a dated proof of purchase and a Returned Material Authorization (RMA) number supplied by Wilson Electronics. Wilson Electronics shall, at its option, either repair or replace the product. Wilson Electronics will pay for delivery of the repaired or replaced product back to the original consumer if located within the continental U.S.

This warranty does not apply to any Signal Boosters determined by Wilson Electronics to have been subjected to misuse, abuse, neglect, or mishandling that alters or damages physical or electronic properties.

Failure to use a surge protected AC Power Strip with at least a 1000 Joule rating will void your warranty.

RMA numbers may be obtained by contacting Technical Support at 866-294-1660.

**Disclaimer:** The information provided by Wilson Electronics, LLC is believed to be complete and accurate. However, no responsibility is assumed by Wilson Electronics, LLC for any business or personal losses arising from its use, or for any infringements of patents or other rights of third parties that may result from its use.

Copyright © 2014 Wilson Electronics, LLC All rights reserved.

U.S. Patent Nos.—7,221,967; 7,729,669; 7,486,929; 7,409,186; 7,783,318; 8,583,034; 8,583,033



3301 East Deseret Drive, St. George, UT 84790  
web: [www.WilsonElectronics.com](http://www.WilsonElectronics.com) | email: [tech@wilsonelectronics.com](mailto:tech@wilsonelectronics.com)  
phone: 866-294-1660 | local: 435-673-5021 | fax: 435-656-2432

YouTube  